



**WINDOW SPRINKLERS
MODEL WS**

DESCRIPTION AND OPERATION

Globe's Model WS Window Sprinklers are specially designed open style nozzles that provide a 180° relatively flat fan-shaped spray pattern. They are generally used to provide a water curtain over a glass window or other opening to prevent fire / heat penetration. They are also used to provide fire exposure protection from one closely located building to another and are also frequently used to protect steel beams and columns to help preserve structural integrity.

The water flow to Globe's Model Window Sprinkler is controlled either by a manually operated control valve or by means of an automatically operated deluge system.

Globe's Model WS Window Sprinklers may be installed in various positions depending on the hazard being protected. The Window Sprinkler installation diagram shown on this page represents a typical installation for the protection of glass windows. However, N.F.P.A. 13 should be consulted for the proper installation and spacing of the Globe Model WS Window Sprinklers.



**WINDOW
SPRINKLER**

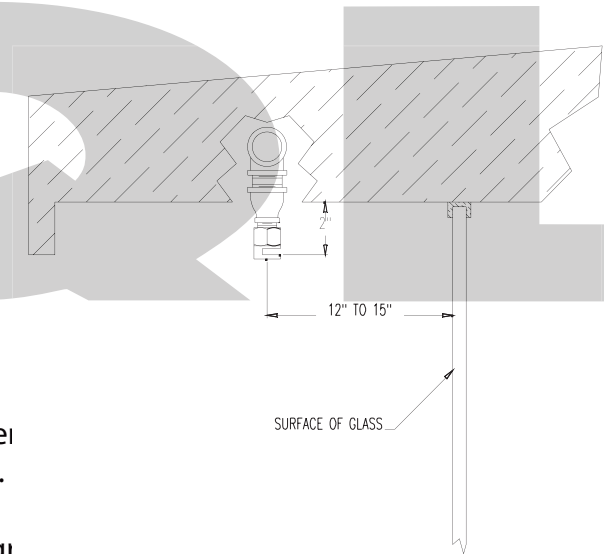

TYPICAL INSTALLATION

APPROVALS

- cULus Listed

TECHNICAL DATA

- Body - brass
- Finish - brass and chrome; other available upon request.
- Weights:
1" Hex .25 lbs. (113.40 grams),
1 1/4" Hex .30 lbs. (136.08 grams).

ORIFICE SIZE		THREAD SIZE		K FACTOR		HEIGHT	
U.S.	Metric	U.S.	Metric	U.S.	Metric	U.S.	Metric
1/4"	6.35 mm	1/2"	15 mm	1.4	20	1 3/4"	44.45 mm
5/16"	7.94 mm	1/2"	15 mm	2.0	29	1 3/4"	44.45 mm
3/8"	9.52 mm	1/2"	15 mm	2.8	40	1 3/4"	44.45 mm
7/16"	11.11 mm	1/2"	15 mm	4.2	59	1 3/4"	44.45 mm
1/2"	12.70 mm	1/2"	15 mm	5.6	80	2 1/16"	52.39 mm
17/32"	13.49 mm	3/4"	20 mm	8.1	116	2 1/16"	52.39 mm
5/8"	15.88 mm	3/4"	20 mm	11.4	163	2 1/16"	52.39 mm



**WINDOW SPRINKLERS
MODEL WS**

SPRAY PATTERNS - TOP VIEW

(CIRCLED NUMBERS REPRESENT PRESSURE IN PSI)

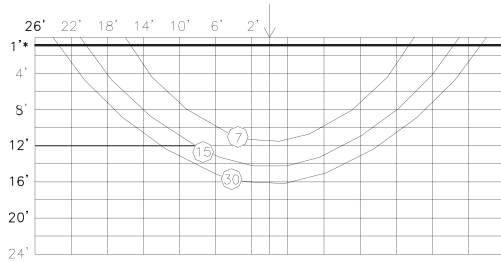

1/4" ORIFICE-K=1.4

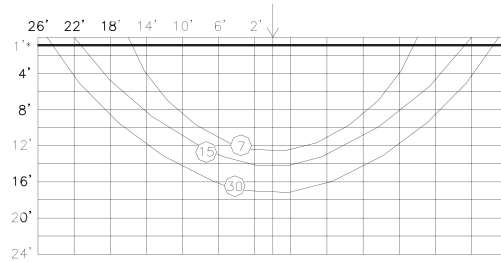

5/16" ORIFICE-K=2.0

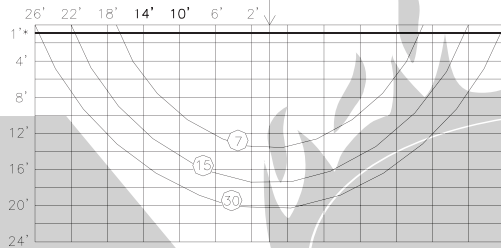

3/8" ORIFICE-K=2.8

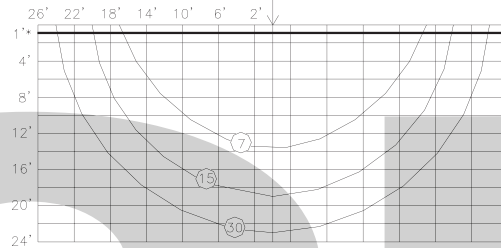

7/16" ORIFICE-K=4.2

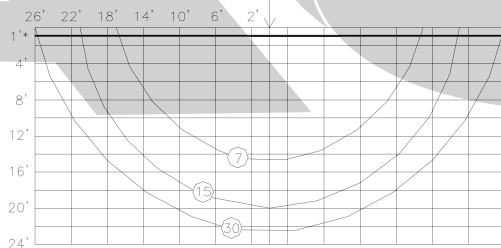

1/2" ORIFICE-K=5.6

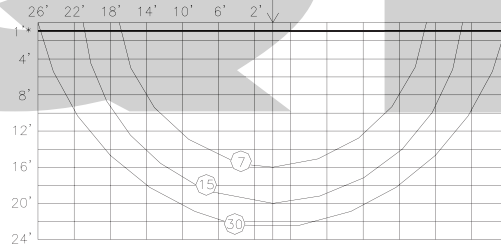

17/32" ORIFICE-K=8.1

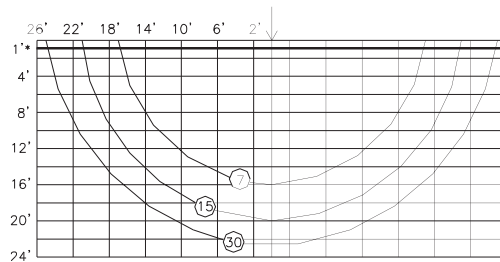

5/8" ORIFICE-K=11.4

*Typical position of window.

ORDERING INFORMATION

SPECIFY

- Quantity • Model Number • Finish
- Orifice • Thread Size

GLOBE® PRODUCT WARRANTY

Globe agrees to repair or replace any of its own manufactured products found to be defective in material or workmanship for a period of one year from date of shipment.

For specific details of our warranty please refer to Price List Terms and Conditions of Sale (Our Price List).